

# Wireless access control solutions

A guide to wireless solutions and connectivity options



# Deliver the value of electronic security with wireless solutions to more doors, more ways.



Reduce the time and costs associated with managing keys due to frequent turnover



Enhance security with more visibility and control



Increase efficiency by enabling updates to occur from virtually anywhere



Mitigate risks associated with lost or stolen keys, provides a detailed audit of events



Increase satisfaction by enabling convenient smart or mobile credential use



Integrates seamlessly into existing PACS systems<sup>1</sup>

<sup>1</sup> For information on PACS providers and their capabilities visit [us.allegion.com/alliances](http://us.allegion.com/alliances).

# Real time and Wi-Fi<sup>®</sup> based offline solutions

## Real-time network benefits



- Highest levels of security control providing bi-directional updates for event notification and access changes along with real-time lockdown capability
- Flexible solutions include two options for real time communication
- Number of users and audits is dependent on access control solution and can be unlimited

## Wi-Fi<sup>®</sup> offline network benefits



- Convenient and efficient remote management with daily scheduled updates
- Updates occur automatically once or more<sup>1</sup> daily between host and door, for capture of historical events and remote access changes
- The locking device manages access based on latest update from access control software
- Bluetooth mobile device compatibility allows option for immediate updates to be made at the door



<sup>1</sup> Dependent on access control provider solution.

# Flexible options to fit your needs



## Schlage LE mobile enabled wireless mortise lock<sup>1</sup>

- Elegant mortise and mortise deadbolt options
- Ideal for suite entrances, offices, and common areas
- Compatible with Bluetooth® and NFC mobile, smart and proximity credentials<sup>1</sup>

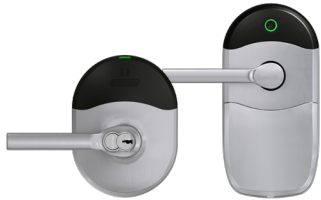

## Schlage NDE mobile enabled wireless cylindrical lock<sup>1</sup>

- Refined design for doors with cylindrical prep
- Ideal for suite entrances, offices, and common areas
- NDEB option includes interior push button with indication for additional functionality
- Compatible with Bluetooth and NFC mobile, smart and proximity credentials<sup>1</sup>



## Schlage AD-400 wireless lock

- Cylindrical, mortise, mortise deadbolt and exit trim options
- Wireless options for elevator, gate, and handheld use
- Compatible with NFC mobile, smart, proximity and magnetic stripe credentials and PIN codes

## Schlage Control™ mobile enabled deadbolt and interconnected lock<sup>1</sup>

- Designed specifically for multifamily resident doors
- Interconnected option enables single motion egress
- Compatible with Bluetooth mobile and smart credentials<sup>1</sup>



## Schlage CTE single door controller with mobile enabled multi-technology reader<sup>1</sup>

- Interfaces with an electrified lock, electromagnetic lock, electric strike, automatic operator or exit device to control an opening
- Works with Schlage MTB11 or MTB15 multi-technology readers (included)
- Compatible with Bluetooth mobile, smart and proximity credentials<sup>1</sup>

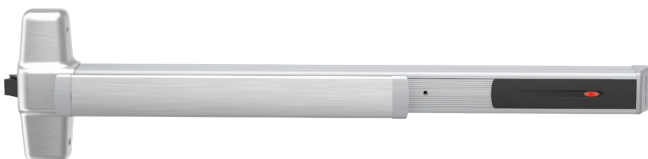

## Von Duprin Remote Undogging/Remote Monitoring (RU/RM) kit

- Enables remote undogging for centralized lockdown on RS-485 or IP installations; daily schedule management of dog on next exit and auto undog via Wi-Fi
- Provides comprehensive real-time monitoring of door position, request-to-exit and latchbolt status signals on RS-485 or IP installations
- Apply to new or existing Von Duprin 98/99 and 33A/35A exit devices

<sup>1</sup> Integration with mobile enabled devices is required by PACS for operation. Use of mobile credential is dependent on availability. For information on PACS providers and their capabilities visit [us.allegion.com/alliances](http://us.allegion.com/alliances).

# Now real-time networked solutions allow 2.4 GHz and 900 MHz wireless devices to co-exist

## 900 MHz solutions

- 900MHz enabled devices connect wirelessly to the Panel Interface Module (PIM)
  - Longer wavelengths allow superior penetration in typical building construction
  - Wireless range up to 200 feet to devices with up to 1000 feet possible in line of sight
  - High gain antenna options can achieve line of sight distances up to 4000 feet
- RS-485 connection through access control panel (ACP) to host
- Access control software manages all device commands and enables lockdown capability



## Bluetooth 2.4 GHz communication

- Bluetooth enabled devices can connect wirelessly to the ENGAGE™ Gateway
  - Range up to 30 feet from gateway to device
  - Multiple ways to connect gateway to host:
    - Ethernet connection direct to host with redundancy present in device
    - RS-485 connection through access control panel (ACP) to host
- Access control software manages all device commands and enables lockdown capability



# Real-time network architecture design

Combining the Gateway and the PIM400 module provides the broadest potential application of wireless solutions for building-wide access control.

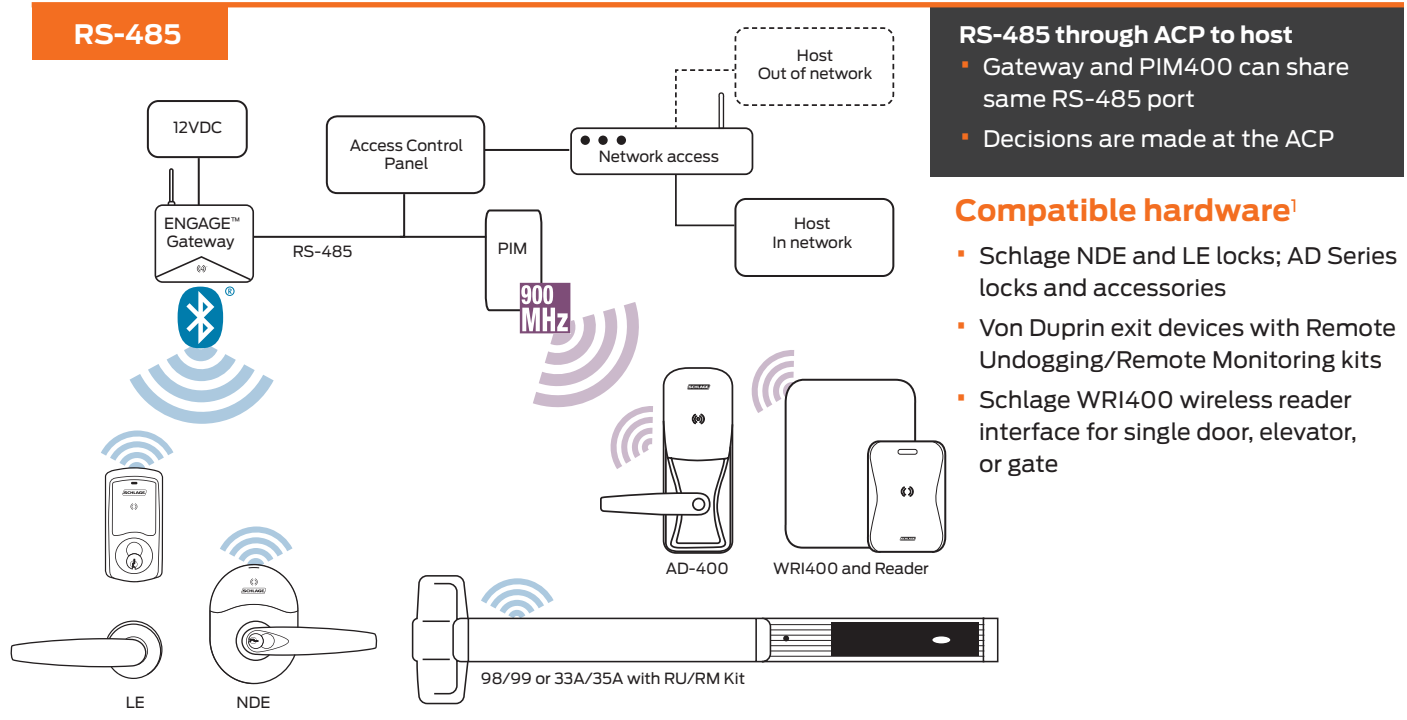

Ethernet connectivity direct to host enables real-time control of devices without an access control panel. This frees capacity on existing ACPs when expanding in an existing environment and reduces hardware needs for new installations.

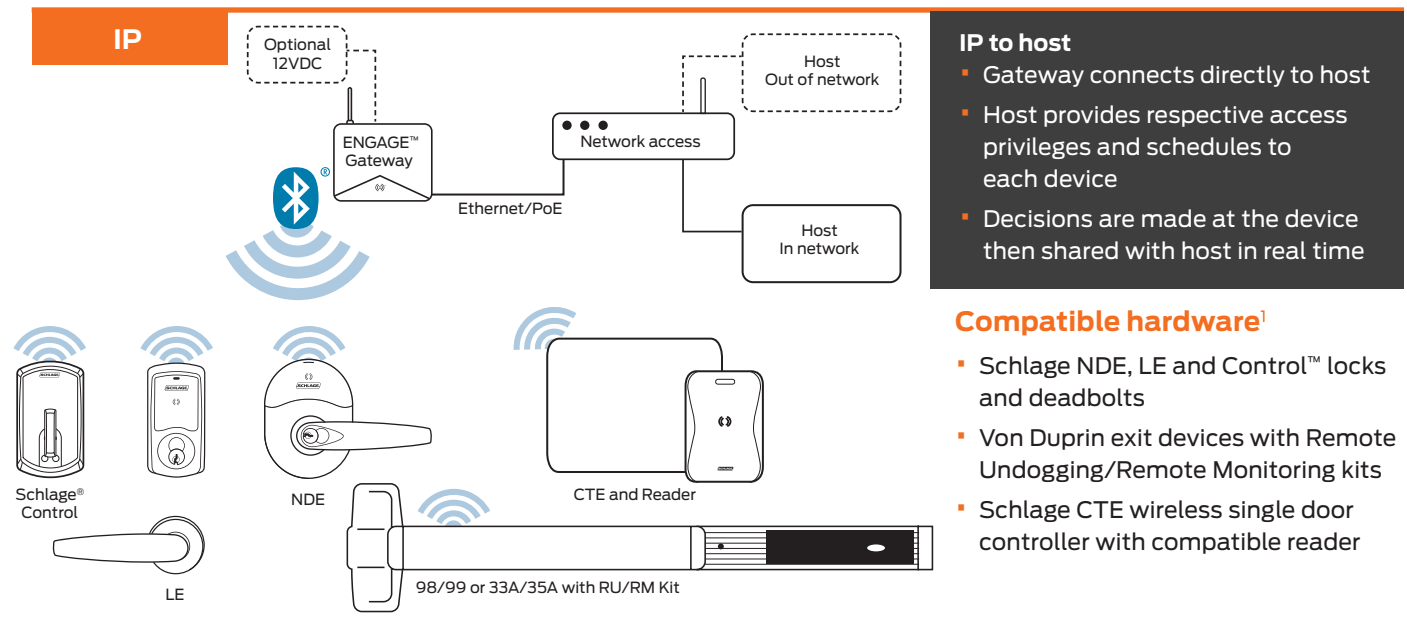

<sup>1</sup> Dependent on access control provider integration.

# Offline solutions utilize Wi-Fi® 2.4 GHz and No Tour options for convenience and savings

## Wi-Fi 2.4 GHz communication

- Utilize existing Wi-Fi architecture for lower infrastructure and installation costs – no panel or gateway required
- Use existing 2.4 GHz Wi-Fi access points for connectivity direct to host software
- Updates occur automatically once or more<sup>1</sup> daily as scheduled between host and door
- Select status updates can be sent in real-time to host software (forced door, tamper, low battery)

## No Tour solutions

- Smart credentials allow users to carry access rights and updates to device at door
- Lowest infrastructure and installation cost to manage – no panel or gateway required
- Event audits captured in the device can be obtained on demand by visiting and connecting to device with mobile application



<sup>1</sup> Dependent on access control provider solution.

# Offline solutions that are easy to manage

Using a Wi-Fi® based network, the benefits of electronic access control can be gained with limited investment and expanded to a real-time network later if desired.

## Wi-Fi

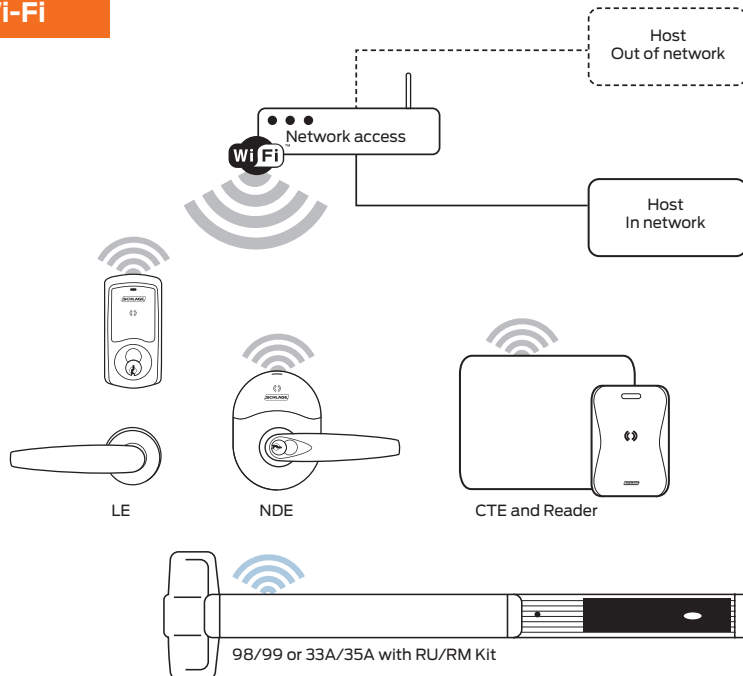

Connect to the access control system over the IT network and gain many benefits of electronic access control without the cost of a full, real-time network.

- Manage user access from anywhere
- Daily automated updates
- Real-time communication alerts for forced door, tamper, and low battery
- Configuration via mobile device

### Compatible hardware<sup>1</sup>

- Schlage NDE and LE locks
- Schlage CTE wireless single door controller with compatible reader
- Von Duprin exit devices with Remote Undocking/Remote Monitoring kit

You can easily enroll and configure smart credentials to carry updates to the device.

## No Tour

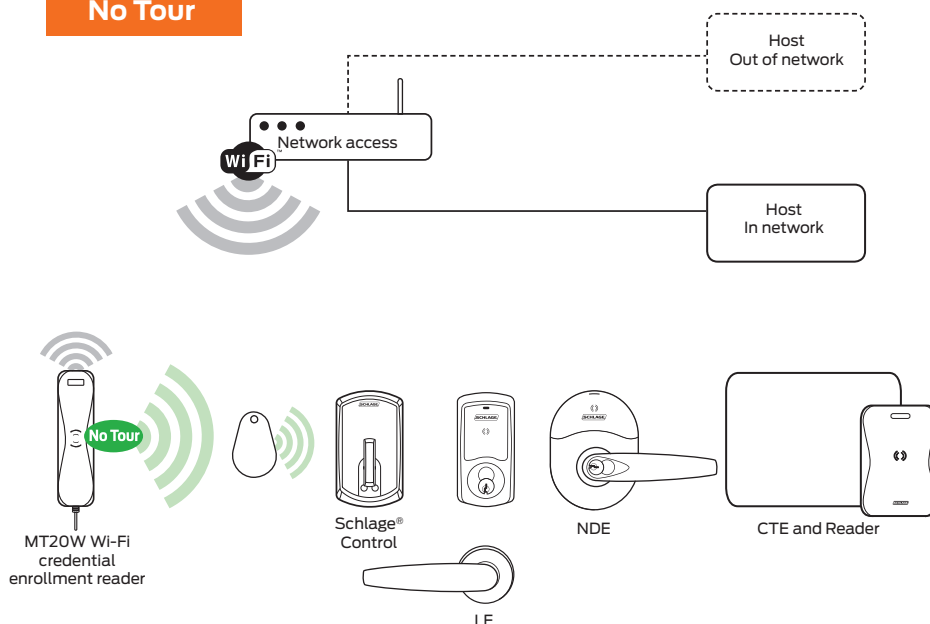

Credentials provide updates to the device and initiate access rights without touring the lock. The Schlage enrollment reader, a Wi-Fi® network and a PACS web or mobile app is all that is needed. Mobile app can obtain audit events at the device as needed.

### Compatible hardware<sup>1</sup>

- Schlage NDE, LE and Control™ locks and deadbolts
- Schlage CTE wireless single door controller with compatible reader
- Schlage MT20W enrollment reader and Schlage Smart credentials with minimum memory size of 8k bit/1K byte

<sup>1</sup> Dependent on access control provider integration.



# Lever designs and finishes

Schlage's broad portfolio of levers and finishes allow you to suite the entire building

## AD-400

The AD-400 is available in eight Schlage lever designs.



Athens



Sparta



Rhodes

## NDE

The NDE is available in nine popular lever designs.



Athens



Sparta



Rhodes

## LE

The LE is available in 31 lever designs including the decorative M collection and 2 knob designs.



07



17



06

## Schlage Control™ Interconnected

The Schlage Control™ Interconnected Lock is available in 15 lever designs with coordinating roses to match the Greenwich or Addison design.



Jupiter

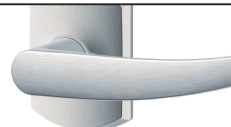





Neptune

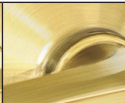

Saturn

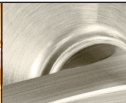
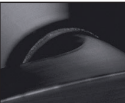
## Lock finish options

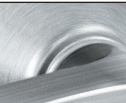
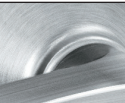
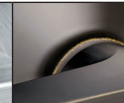
									
<b>Color</b>	Bright brass	Satin brass	Satin bronze	Satin nickel	Matte black	Bright chrome	Satin chrome	Satin chrome with anti-microbial	Aged bronze
<b>ANSI/BHMA number</b>	605	606	612	619	622	625	626	626AM	643e/716
<b>US number</b>	US3	US4	US10	US15	US19	US26	US26D	US26D	US11
<b>AD</b>	■	■	■	■		■	■	■	■(643e)
<b>NDE</b>	■	■	■	■	■	■	■	■	■(643e)
<b>LE</b>	■	■	■	■	■	■	■	■	■(643e)
<b>Control</b>				■	■	■	■		■(716)

# Utilize Schlage readers and credentials to complement the solution



## Schlage smart credentials provide unique value:

### Open architecture

Schlage secures the access control application sector, but the remaining sectors are open for you to work with any company you choose.

### Secure data and communications

Credentials using MIFARE® DESFire® offer Schlage's highest level of security through the use of mutual authentication, key diversification, and encryption.

### Custom programming

Program any smart cards and readers with your custom key format and proprietary bit format.



## Smart vs. Prox

### Proximity

- Data is stored but not encrypted
- Rigid storage that can't be change
- Can only store one number
- Slower communication speed
- Easily duplicated

### Smart

- Data is stored and encrypted
- Has dynamic storage that can be changed
- Can store a variety of data
- Faster communication speed
- Difficult to duplicate

Consult your Allegion representative to learn more about our full credential offering.

## About Allegion

Allegion (NYSE: ALLE) is a global pioneer in safety and security, with leading brands like CISA®, Interflex®, LCN®, Schlage®, SimonsVoss® and Von Duprin®. Focusing on security around the door and adjacent areas, Allegion produces a range of solutions for homes, businesses, schools and other institutions. Allegion is a \$2 billion company, with products sold in almost 130 countries.

For more, visit [www.allegion.com](http://www.allegion.com)

KRYPTONITE ■ LCN ■  ■ STEELCRAFT ■ VON DUPRIN